

型号编制说明 Model Schedule Illustration

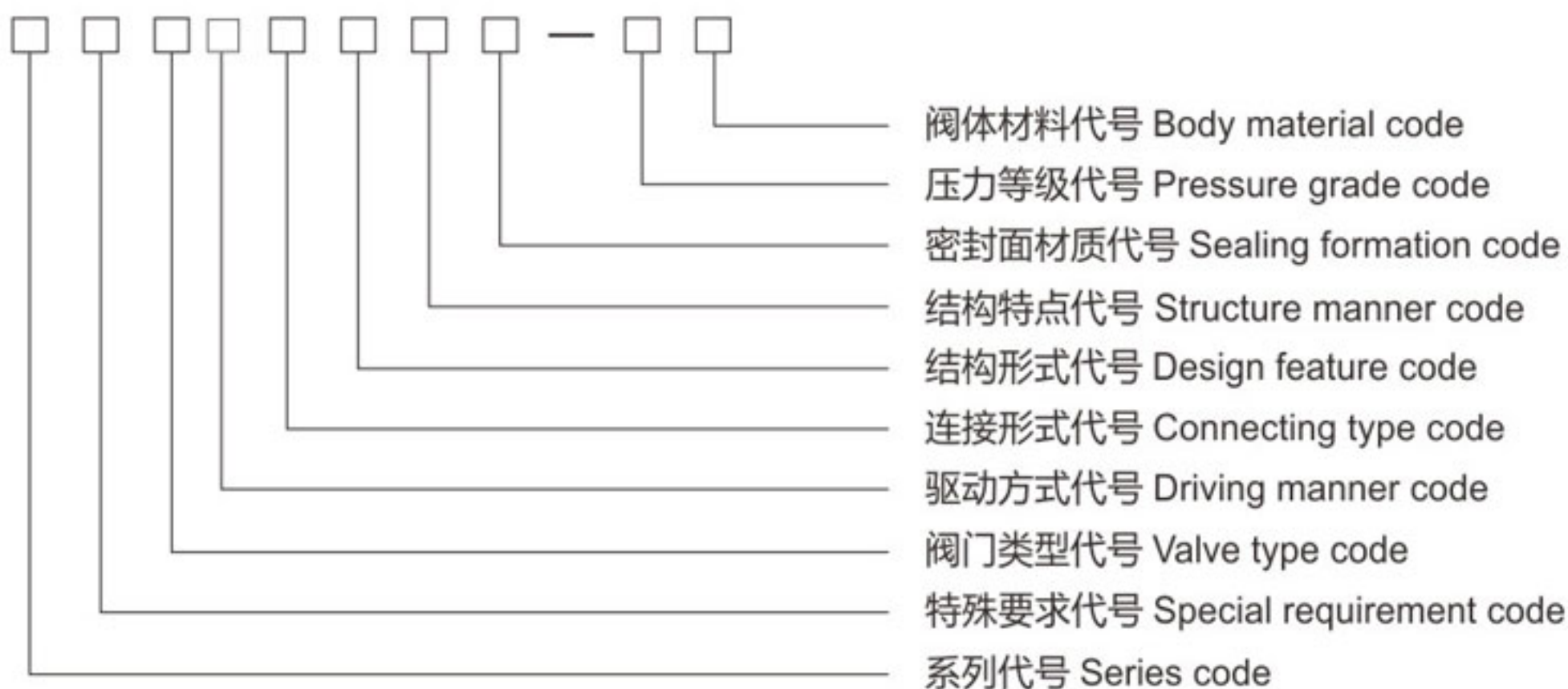

特殊要求代号: K—抗硫型 L—调节型 ZB—自动补偿

阀门类型代号: Z—闸阀

驱动方式代号: 4—正齿轮传动 5—伞齿轮传动 6—气动 6s—气动带手动 7—液动 9—电动(手轮传动略) 9e—防爆电动

连接形式代号: 4—法兰连接 6—对焊连接

结构形式代号: 3—明杆平行式单闸板 4—明杆平行式双闸板

结构特点代号: W—无导流孔(有导流孔省略) P—轻型

密封面材质代号: Y—硬质合金 H—合金钢 D—渗氮钢 F—增强聚四氟乙烯

压力等级代号: 公称压力为MPa的10倍、磅级为实际数

阀门材料代号: C—WCB I—WC6, ZG1Cr5Mo V—WC9, ZG20CrMoV P—CF8, ZG1Cr18Ni9Ti
R—CF8M, ZG1Cr18Ni12Mo2Ti S—CF3 L—CF3M F—LCB N—LC3

例1: Z543WF-16C

注释: 公称压力为1.6MPa, 伞齿轮传动、法兰连接、无导流孔、明杆平行式单闸板闸阀, 阀体材质为WCB, 密封面材质为增强聚四氟乙烯。

例2: KZ9B44Y-150Lb

注释: 压力等级为Class150, 防爆电动、法兰连接、有导流孔、抗硫明杆平行式双闸板闸阀, 阀体材质为WCB, 密封面材质为硬质合金。

Special requirement code: K—Antisulphur model L—Adjustment type ZB—Auto compensation

Valve type code: Z—Gate valve

Driving manner code: 4—Spur gear transmission 5—Bevel gear transmission 6—Air driving 6s—Take pneumatically manually 7—Hydrodynamic driving 9—Electric driving (Hand wheel driving omitted) 9B—Explosion electric driving

Connecting type code: 4—Flange-connecting 6—Butt welding connecting

Design feature code: 3—Rising-stem parallel single-disc 4—Rising-stem parallel double-disc

Structure manner code: W—Non-diversion hole type (Diversion hole type omitted) P—Light-duty

Sealing formation code: Y—Hard alloy H—Alloy steel D—Nitriding steel F—Intensified polytetrafluoroethylene(PTFE)

Pressure grade code: The 10 times of the nominal pressure MPa, pound grade is practical number

Body material code: C—WCB I—WC6, ZG1Cr5Mo V—WC9, ZG20CrMoV P—CF8, ZG1Cr18Ni9Ti R—CF8M, ZG1Cr18Ni12Mo2Ti
S—CF3 L—CF3M F—LCB N—LC3

Example1: Z543WF-16C

Denoting 1.6MPa nominal rating pressure, bevel gear transmission, flange-connecting, nondiversion hole, Rising-stem parallel single-disc, WCB valve body material and the Intensified polytetrafluoroethylene(PTFE) as sealing material.

Example2: KZ9B44Y-150Lb

Denoting Class150 pressure grade, explosion electric driving, flange-connecting, diversion hole type, antisulphur rising-stem parallel double-disc gate valve, WCB valve body material and the hard alloy sealing material.

• 平板闸阀

产品结构特点 Products Design Features

1. 阀体有铸造和焊接两种结构。
2. 阀座采用O形密封圈密封和施加预紧力的浮动阀座结构，使阀门进出口双向密封；并且该结构的启闭力矩仅为普通阀门的1/2，能达到轻松开/关阀门。
3. 修阀座采用密封面上镶嵌PTFE，具有PTFE对金属和金属对金属的双重密封，PTFE密封面同时清除闸板脏物的作用。
4. 金属对金属密封的阀门，阀体外部设有注油脂结构，油脂通过注脂器、阀座进入阀门密封面，使阀门达到零泄漏。
5. 带导流孔阀门的闸板，无论是全开或是全关始终与密封面吻合，密封面得到保护不受介质直接冲刷，从而延长使用寿命。
6. 阀门在全开时，通道平滑为直线，流阻系数极小，无压力损失，可通毛球清扫管线。
7. 本阀门采用带自密封能力的填料结构，无需经常调节，开/关极为轻便，且密封性可靠，填料函处设有辅助密封油脂注入结构，密封性能绝对可靠，真正达到零泄漏；解决了通用阀门填料处最容易外漏的弊病。
8. 阀门关闭时能自动卸掉内腔高压(详见工作原理图)，保证使用安全。
9. 全封闭结构，防护性能好，可适应全天候要求。
10. 阀门设有指示杆或观察窗以表示阀门的启闭情况。

1. Cast and weld two structures with the body
2. The seat ring uses the floating seat ring structure with o-seal ring sealed and pre-tightening force applied to have inlet and outlet dual-way sealed; and the open-close moment with this structure is 1/2 that of the common valves only, able to lightly open and close valves.
3. The seat ring uses the sealing face inlaid with PTFE, so has dual seals of PTFE to metal and metal to metal, the PTFE sealing face also acts as removing the dirt on the wedge disc.
4. For the valve with the metal to metal seal, there is grease injector outside of it, grease gets into the sealing face through the injector and the seat ring to have the valve up to null leak.
5. The wedge disc of the valve with flow guide hole is always fitted with the sealing face whether in full open or full close status to have the sealing face protected without being directly eroded by the medium so as to extend the duration.
6. When fully opened, the valve's channel is smooth and linear, with an extremely small flow resisting coefficient and no pressure loss, and the pipeline can be cleaned with hair-ball through it.
7. This valve uses the packing structure with the ability of self-seal, needs no constant adjustment, features very light open and close and a reliable seal. An assisting sealing grease injection structure is set in the packing to have the sealing performance absolutely reliable and get a true null leak, settling the problem for the packing place of universal valves to be easiest leak outward.
8. Automatic removal of the high pressure in the internal cavity when the valve is about to close (see the working principle diagram for the details) so as to ensure safety.
9. Fully sealed structure leaves a good protective property, suitable for the requirement of 24-hour duty.
10. An indication rod or viewing window is set with the valve to show the open-close condition.

产品性能规范 Products Performance Specification

压力等级 Pressure	常温试验压力(MPa) Testing pressure at constant temperature (Mpa)					适用温度 Applicable temperature	适用介质 Applicable medium	
	壳体试验 The shell testing	左密封 The left sealing	右密封 Right sealing	低压气密封 Low pressure air tightness	普通型 Ordinary type		抗硫型 Anti sulphur type	
公称压力 (MPa) Nominal rating pressure (PN)	1.6	2.4	1.76	1.76	0.6	-29~121°C 或按用户要求	石油、天然气、 水等非腐蚀性介质	含H ₂ S、CO ₂ 的石油、 天然气、 水等腐蚀性介质
	2.5	3.75	2.75	2.75	0.6			
	4.0	6.0	4.4	4.4	0.6			
	6.4	9.6	7.04	7.04	0.6			
	10.0	15.0	11.0	11.0	0.6			
	16.0	24.0	17.6	17.6	0.6			
磅级(Lb) Pound grade (Class)	150	3.0	2.2	2.2	0.6	-29~121°C or upon the user requirement	Petroleum, natural gas.water etc.non-corrosive media	Petroleum,natural gas, water etc, containing H ₂ S, CO ₂ corrosive media
	300	7.5	5.5	5.5	0.6			
	600	15.0	11.0	11.0	0.6			
	900	22.5	17.5	17.5	0.6			

• 平板闸阀

工作原理 Working Principle



图1

1. 阀门内部压力相当时(1), 闸板处于闭合状态, 阀座表面PTFE密封环形成初始密封, 每次阀门开或关时, 阀座圈能清洁闸板两侧。(如图1)

With equal pressure throughout the valve (and the gate in closed position), and initial seal (1) is formed with the raised PTFE ring on the faces of the seats. (The seat-inserts clean both sides of the gate each time the valve is opened or closed)

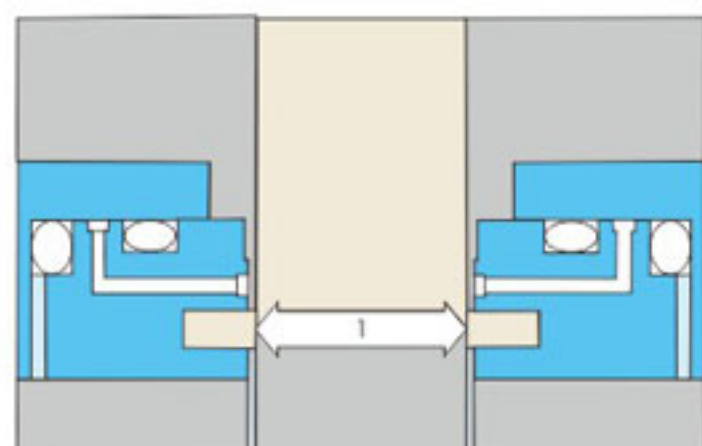

图2

2. 对阀门施加管道压力时(2), 压力作用于闸板, 迫使它贴近出口阀座上的PTFE环, 压缩它直到闸板停在钢制阀座上, 这样就形成了双重密封, 首先是PTFE对金属密封, 然后是金属对金属密封, 阀座也被牢固地推到凹槽, 在这一点(3), O形圈阻止任何后部介质流。(如图2)

As line pressure (2) is applied to the valve, it acts on the gate, forcing it against the PTFE ring on the downstream seat, compressing it until the seat against the steel seat. Thus, a double seal is formed...first, a PTFE-to-metal seal; then, metal-to-metal. The seat is also forced firmly into its recess. The O-ring (3) prevents any downstream flow at this point.

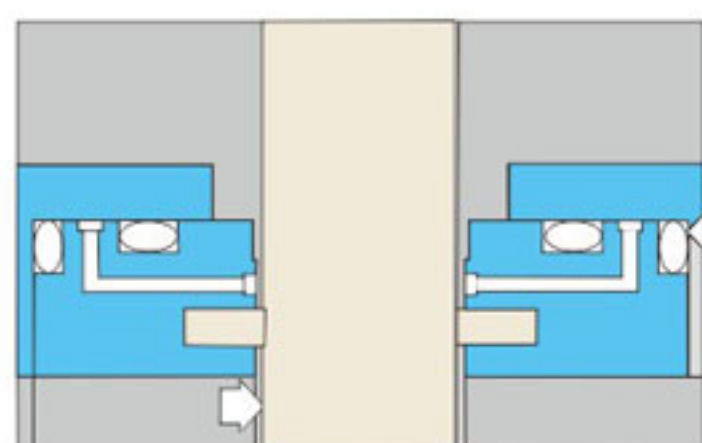

图3

3. 阀腔压力泄放后, 形成进口密封, 管道压力作用于进口阀座(4), 使其移向闸板, 这时形成PTFE对金属的密封, 同时, O形圈(5)与阀座凹槽形成紧密的密封。(如图3)

Upstream seal is provided when valve cavity pressure is bled off. This is caused by the force of line pressure acting against the upstream seat (4) moving the seat against the gate and providing a tight PTFE-to metal seal at this point. At the same time, the O-ring (5) forms a tight seal with the seat recess.

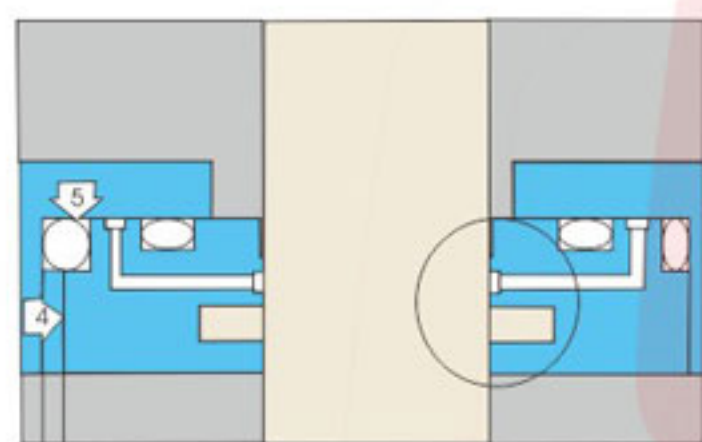

图4

4. 阀门自动泄放多余的压力, 当阀腔压力大于管道压力时, 由于热膨胀, 进口阀座推向凹槽, 阀腔内多余的压力在阀座与闸板之间泄放到管道中。(如图4)

Valve automatically relieves itself of excessive valve cavity pressure. When valve cavity pressure exceeds line pressure...from such causes as thermal expansion...the upstream seat is forced back into its recess and the excess pressure in the valve cavity is bled between the seat and the gate into the line.

产品主要参数 Main Parameter Of The Products

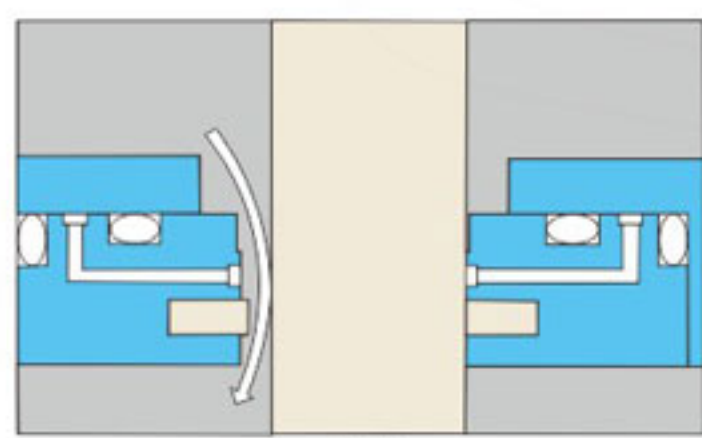
基本型号 Serial models	SY(K)Z43WF、SY(K)Z43WY、SY(K)Z43WD、SY(K)Z44WF、SY(K)Z44WY、SY(K)Z44WD SY(K)Z543WF、SY(K)Z543WY、SY(K)Z543WD、SY(K)Z544WF、SY(K)Z544WY、SY(K)Z544WD SY(K)Z643WF、SY(K)Z643WY、SY(K)Z643WD、SY(K)Z644WF、SY(K)Z644WY、SY(K)Z644WD SY(K)Z943WF、SY(K)Z943WY、SY(K)Z943WD、SY(K)Z944WF、SY(K)Z944WY、SY(K)Z944WD			
压力等级范围 Pressure grade range	PN1.6~15.0MPa		Class150~900	
口径范围 Drift diameter range	DN25~ 1000mm		1"~40"	
驱动方式 Driving manner	手轮驱动 Hand wheel driving		齿轮动、气动、液动、电动 Gear driving, air-operating, hydrodynamic driving and electric driving	
适用范围 Scope of application	Class150~300 (PN1.6-4.0)	Class400 (PN6.4)	Class600~900 (PN10.0-15.0)	Class150~900
	1"~40" (DN25~ 1000mm)	1"~28" (DN25-700mm)	1"-12" (DN25-300mm)	1"~4" (DN25~1000mm)

• 平板闸阀

流量特性分析

带导流孔的平板闸阀，其流量特性等同于同规格的管道，呈等百分比特性，不带导流孔的平板闸阀，其中腔跨度较楔式闸阀小，且属于规则的圆柱体，所以，基本上除压力损失较带导流孔的大外，其余特性基本接近。不带导流孔调节型的平板闸阀其对流量的调节特性优于普通不带导流孔的平板闸阀。

Flow Characteristic

The flow characteristic of flat gate valves with a diversion hole is equal to that of pipelines of the same specification. The characteristic is shown in percent form. As for valves without a diversion hole, its cavity fly span is smaller than that of wedge gate valves and it is a regular cylindrical object, therefore, characteristics of the valves are similar except that they have a larger pressure loss. Besides, their flux adjustment behavior is better than that of the ones with a diversion hole.

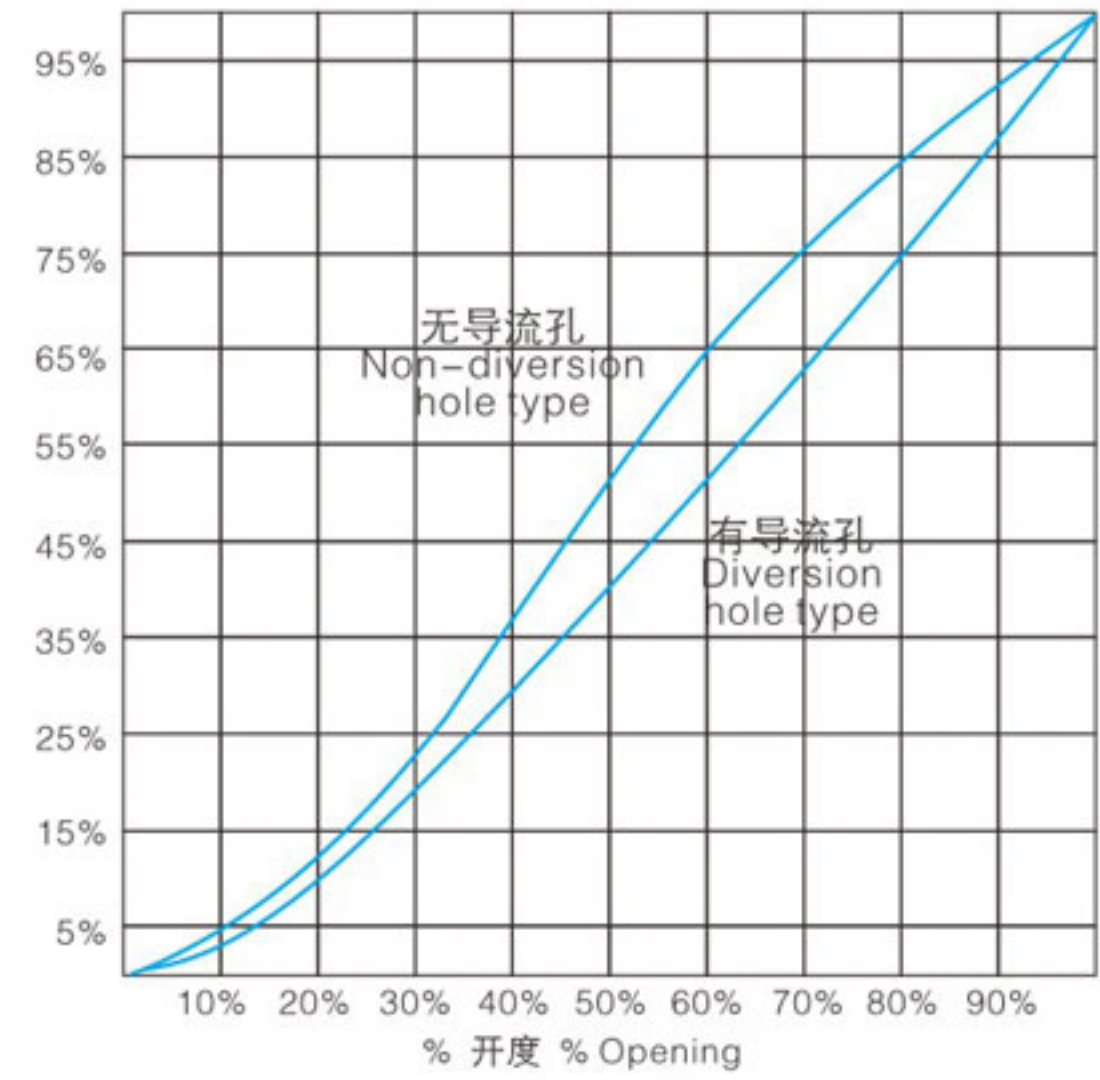

阀门开度—Cv特性曲线表
Valve-opening—Cv characteristic graph

各类型闸板外形图 Outside Drawing Of Different Types Of Shutter



带导流孔型平板闸阀的 DN—Cv曲线图 DN - Cv Graph Of Flat Valves With A Diversion Hole

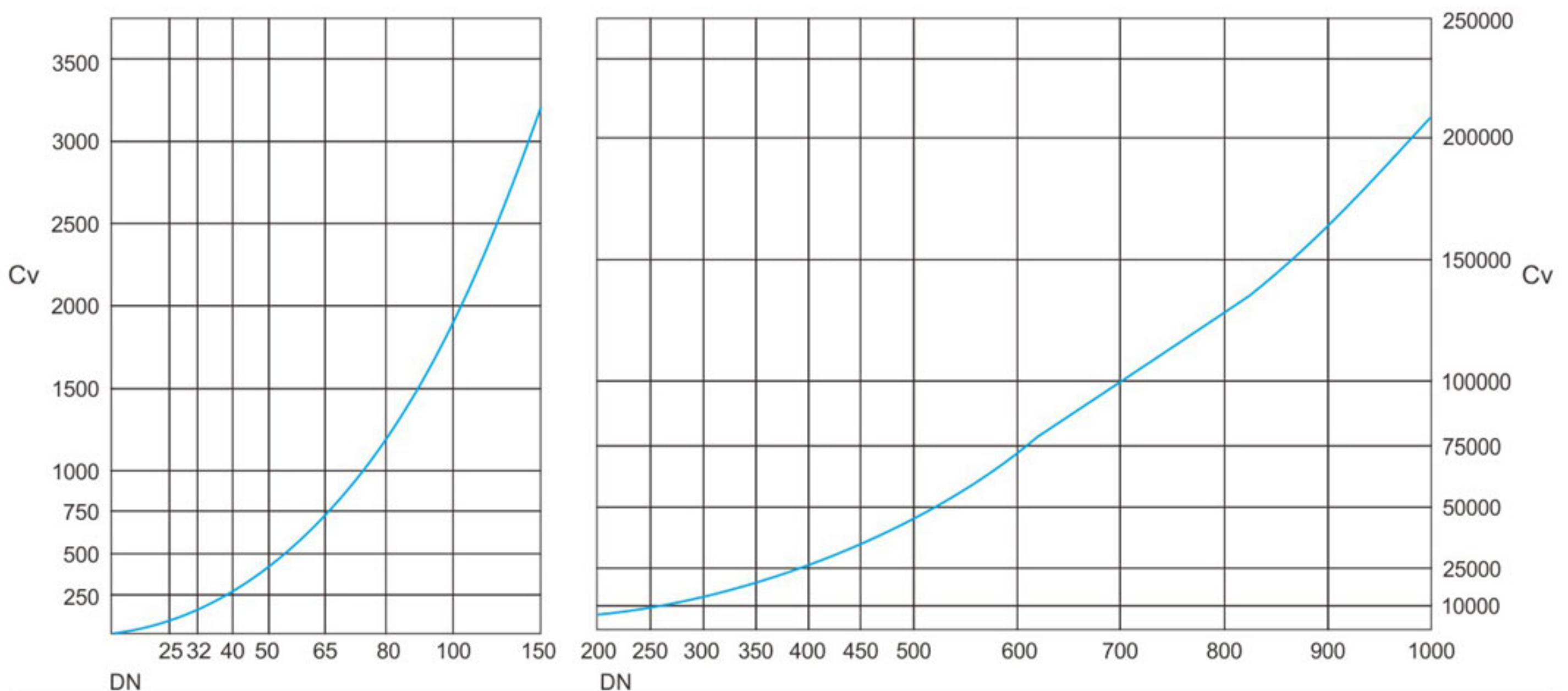

Double-disc parallel gate valve

• 平行式双闸板闸阀

(K)ZF44XY(K)ZF 9/544 XY-(1.6-42.0MPa)

试验压力 Experimental Pressure

公称压力 PN (MPa)	壳体 Shell body	密封(液) Seal (liquid)	密封(气) Seal(liquid)	上密封 Upper Seal
1.6	2.4	1.8	0.6	1.8
2.5	3.8	2.8	0.6	2.8
4.0	6.0	4.4	0.6	4.4
6.4	9.6	7.0	0.6	7.0
10.0	15.0	11.0	0.6	11.0
16.0	24.0	18.0	0.6	18.0

适用范围 Suitable Conditions

壳体材料 Material for shell body	适用介质 Applicable medium	适用温度°C Suitable Temperature
碳素钢(C型) Carbon steel (type C)	水、蒸气、油品 Water, smoke, oil	≤425°C
铬镍钛钢(P型) Chrom- nickel titanium steel (Type P)	硝酸类 same kinds of nitric acid	≤200°C
铬镍钼钛钢(R型) Chrome- nickel molybdenm titanium steel	醋酸类 same kinds of vingar acid	≤200°C
铬钼钢(I型) Chrome- molybdenm steel	水、蒸A气、油品 Water, smoke, oil	≤550°C

主要零件材料 Materials For Mainparts

阀体、阀盖 Body, Cover	闸板、闸座 Gate, Seat	阀杆 Valve Bar	阀杆螺母 Stem nut	填料 Stuffing	手轮 Hand wheel
碳素钢 Carbon Steel	优质钢+硬质合金或不锈钢 High quality steel hard quality alloy/ stainless steel	铬钼钢 Chrome stainless steel	铝青铜 Aluminium-bronze	石墨石棉盘根 Black lead Asbestos	可锻铸铁 Malleable iron
铬镍钛钢 Chrom- nickel titanium steel (Type P)	不锈钢、不锈钢+硬质合金或不锈钢 Stainless steel / Stainless steel+ hard quality alloy	铬镍钼钛钢 Chrome- nickel titanium stainless	铝青铜 Aluminium-bronze	聚四氟乙烯 PTFE	可锻铸铁 Malleable iron
铬镍钼钛钢 Chrome- nickel molybdenm titanium steel	不锈钢、不锈钢+硬质合金或不锈钢 Stainless steel / Stainless steel+ hard quality alloy	铬镍钼钛钢 Chromenickel - molybdenm titanium stainless steel	铝青铜 Aluminium-bronze	烯石棉盘根 Ethylene Asbestos	可锻铸铁 Malleable iron
铬钼钢 Chromemolybdenm steel	合金钢+硬质合金 Alloy steel + hard quality alloy	铬钼钼钢 Chromemolybdenm aluminium steel	铝青铜 Aluminium-bronze	柔性石墨 Expanded graphite	铬钼可锻铸铁 Malleable and Chrome molybdenumiron

注：抗流阀门型号前加(K)

Note:Put "K" in front of the code of the choking valve

• 平行式双闸板闸阀

(K)ZF44XY(K)ZF 9/544 XY-(1.6-42.0MPa)

主要外形尺寸和连接尺寸 Main Dimensions And Connection Dimensions

公称通径 DN(mm)	L	D	D1	D2	b	f	z-d	H	H1	D0	重量WT (kg)
ZF44XY-16C ZF44XY-16P ZF44XY-16R ZF44XY-16I											
20	150	105	75	55	14	2	4-14	255	284	140	6.5
25	160	115	85	65	14	2	4-14	275	303	160	9
32	180	135	100	78	14	2	4-18	280	321	180	12
40	200	145	110	85	16	3	4-18	300	352	200	36.5
50	250	160	125	100	16	3	4-18	358	438	240	29
65	265	180	145	120	18	3	4-18	375	450	240	33
80	280	195	160	135	20	3	8-18	433	528	280	45
100	300	215	180	155	20	3	8-18	502	620	300	63
125	325	245	210	185	22	3	8-18	612	753	325	108
150	350	280	240	210	24	3	8-23	676	847	340	134
200	420	335	295	265	26	3	12-23	820	1039	400	192
250	470	405	355	320	30	3	12-25	969	1245	450	273
300	500	460	410	375	30	3	12-25	1142	1472	500	379
350	550	520	470	435	34	4	16-25	1280	1450	550	590
400	600	580	525	485	36	4	16-25	1452	1887	600	850
450	650	640	585	545	40	4	20-30	1541	2011	700	907
500	700	705	650	608	44	4	20-34	1676	2181	700	958
600	800	840	770	718	48	5	20-41	1874	2346	800	1112
ZF44XY-25 ZF44XY-25P ZF44XY-25R ZF44XY-25I											
20	150	105	75	55	16	2	4-14	255	284	140	7
25	160	115	85	65	16	2	4-14	375	303	160	11
32	180	135	100	78	18	2	4-18	280	321	180	14
40	200	145	110	85	18	3	4-18	300	352	200	30
50	250	160	125	100	20	3	4-18	358	438	240	34
65	265	180	145	120	22	3	8-18	375	450	260	36
80	280	195	160	135	22	3	8-18	433	528	280	50
100	300	230	190	160	24	3	8-23	502	620	300	69
125	325	270	220	188	28	3	8-25	612	753	325	116
150	350	300	250	218	30	3	8-25	676	847	340	141
200	420	360	310	278	34	3	12-25	820	1039	400	223
250	470	425	370	332	36	3	12-30	969	1245	450	317
300	500	485	430	390	40	4	16-30	1142	1472	500	400
350	550	550	490	448	44	4	16-34	1280	1450	550	630
400	600	610	550	505	48	4	16-34	1452	1887	600	900
450	650	660	600	555	50	4	20-34	1541	2011	700	1013
500	700	730	660	610	52	4	20-41	1676	2181	700	1166
600	800	840	770	718	56	5	20-41	1874	2346	800	1258

Double-disc parallel gate valve

• 平行式双闸板闸阀

(K)ZF44XY(K)ZF 9/544 XY-(1.6-42.0MPa)

主要外形尺寸和连接尺寸 Main Dimensions And Connection Dimensions

公称通径 DN(mm)	L	D	D1	D2	D6	b	f	f	z-d	H	H1	D0	重量WT (kg)
ZF44XY-40C ZF44XY-40P ZF44XY-40R ZF44XY-40I													
20	150	105	75	55	51	16	2	4	4-14	256	285	140	8
25	160	115	85	65	58	16	2	4	4-14	275	305	160	9.3
32	180	135	100	78	66	18	2	4	4-18	287	322	180	12
40	200	145	110	85	76	18	3	4	4-18	323	369	200	16.5
50	250	160	125	100	88	20	3	4	4-18	372	440	200	29
65	280	180	145	120	110	22	3	4	8-18	395	473	280	39
80	310	195	160	135	121	22	3	4	8-18	457	552	300	52
100	350	230	190	160	150	24	3	4.5	8-23	552	671	300	80
125	400	270	220	188	176	28	3	4.5	8-25	634	726	325	127
150	450	300	250	218	204	30	3	4.5	8-25	708	883	340	154
200	550	375	320	282	260	38	3	4.5	12-30	858	1086	400	263
250	650	445	385	345	313	42	3	4.5	12-34	1015	1298	450	368
300	750	510	450	408	364	46	4	4.5	16-34	1203	1535	500	547
350	850	570	510	465	422	52	4	5	16-34	1341	1678	700	679
400	950	655	585	535	474	58	4	5	16-41	1492	1903	800	953
ZF44XY-64 ZF44XY-64P ZF44XY-64R ZF44XY-64I													
20	190	125	90	68	51	20	2	4	4-18	258	288	180	9
25	210	135	100	78	58	22	2	4	4-18	310	341	10	11
32	230	150	110	82	66	24	2	4	4-23	320	353	200	14
40	240	165	125	95	76	24	3	4	4-23	360	389	240	30
50	250	175	135	105	88	26	3	4	4-23	372	448	280	39
65	280	200	160	130	110	28	3	4	8-23	395	475	280	43
80	310	210	170	140	121	30	3	4	8-23	458	553	300	60
100	350	250	200	168	150	32	3	4.5	8-25	553	679	300	89
125	400	295	240	202	176	36	3	4.5	8-30	638	779	325	140
150	450	340	280	240	204	38	3	4.5	8-34	718	993	340	207
200	550	405	345	300	260	44	3	4.5	12-34	873	1100	400	325
250	650	470	400	352	313	48	3	4.5	12-41	1053	1332	450	467
300	750	530	460	412	364	54	4	4.5	16-41	1203	1535	500	590

• 平行式双闸板闸阀

(K)ZF44XY(K)ZF 9/544 XY-(1.6-42.0MPa)

主要外形尺寸和连接尺寸 Main Dimensions And Connection Dimensions

公称通径 DN(mm)	L	D	D1	D2	D6	b	f	f2	z-d	H	H1	D0	重量WT (kg)
ZF44XY-100 ZF44XY-100P ZF44XY-100R ZF44XY-100I													
25	210	135	100	78	58	24	2	4	4-18	310	341	200	13
32	230	150	110	82	66	24	2	4	4-18	320	353	240	20
40	240	165	125	95	76	26	3	4	4-23	360	389	280	32
50	250	195	145	112	88	28	3	4	4-23	490	558	360	50
65	280	220	170	138	110	32	3	4	8-25	540	622	400	83
80	310	230	180	148	121	34	3	4	8-25	573	671	400	100
100	350	265	210	172	150	38	3	4	8-30	575	671	400	110
125	400	310	250	210	176	42	3	4.5	8-34	744	892	560	180
150	450	350	290	250	204	46	3	4.5	12-34	800	972	560	250
200	550	430	360	312	260	54	3	4.5	12-41	800	972	560	360
250	650	500	430	382	313	60	3	4.5	12-41	1050	1305	640	485
300	750	585	500	442	364	70	4	4.5	16-48	1208	1506	640	633
ZF44XY-160 ZF44XY-160P ZF44XY-160R ZF44XY-160I													
20	190	130	90	62	51	26	2	4	4-23	260	288	200	13
25	210	140	100	72	58	28	2	4	4-23	280	310	280	16
32	230	165	115	85	66	30	2	4	4-25	312	350	320	23
40	240	175	125	92	76	32	3	4	4-25	350	395	320	36
50	300	215	165	132	88	36	3	4	8-25	512	612	360	63
65	340	245	190	152	110	44	3	4	8-30	560	677	360	110
80	390	260	205	168	121	46	3	4	8-30	585	686	400	141
100	450	300	240	200	150	48	3	4.5	8-34	631	751	450	185
125	525	355	285	238	176	60	3	4.5	8-41	723	868	560	320
150	600	390	318	270	204	66	3	4.5	12-41	820	997	640	462
200	750	480	400	345	250	78	3	4.5	12-48	990	1224	720	711

Double-disc parallel gate valve

• 平行式双闸板闸阀

(K)ZF44XY(K)ZF 9/544 XY-(1.6-6.4MPa)

概述 Descriptions

本公司专业生产各类管线平板闸阀，根据各油田输油管线需要，为增大空间便于阀门在管线安装而特别研制成功，短体平行式双闸板闸阀，该产品设计合理，结构紧凑，具有耐磨双闸板结构。双向启闭，开关灵活，密封性能可靠，抗擦伤性能好，具有通球扫线和进出口同时密封功能。

This valve owns features of friction resisting structure, reliable seal, excellent anti-wearing ability, dual-way open-close, and easy operation, also can be cleaned with hair-ball through it.

主要特点及用途 Characteristics & Applications

1. 阀门整体结构根据压力不同分别采用扁体和圆体结构。
 2. 阀座采用金属圈镶嵌PTFE，具有先软后硬的双重密封。
 3. 闸板采用不锈钢或碳钢，表面MOSZ特殊处理。
 4. 浮动闸座的活塞效应可使阀门进出口同时密封。
1. Flat or rounded structure is adopted according to different pressures.
 2. The seat has structure of metal ring inlaid with PTFE, which ensures the seal ability of soft and then hard. The disc adopts stainless steel or carbon steel material, and its surface is treated with MOSZ.
 3. steel material, and its surface is treated with MOSZ.
 4. Piston effect of floating seat leads to dual-way seal for inlet/outlet of the valve.

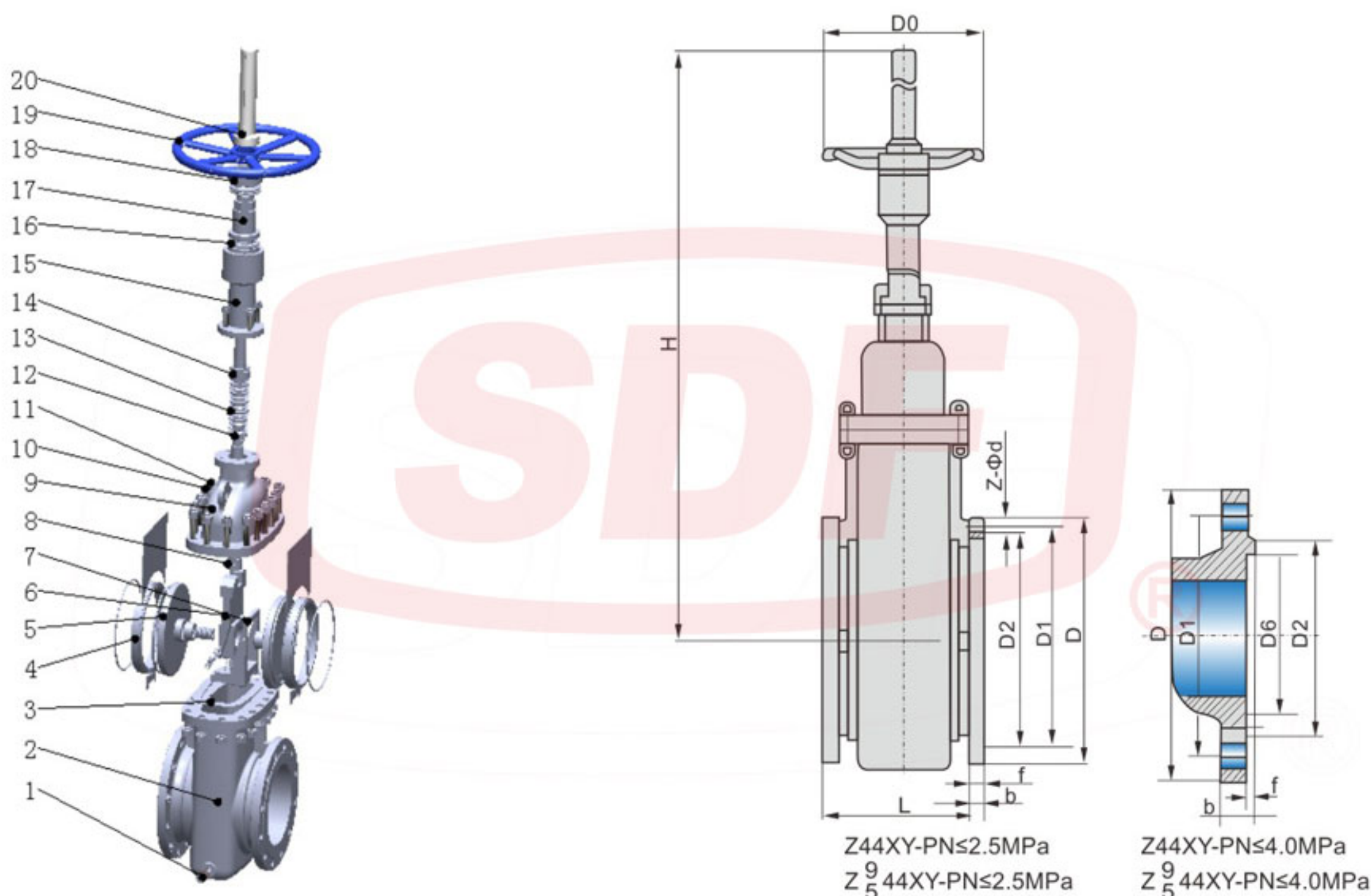

注：抗流阀门型号前加(k) Note: put "k" in front of the code of the choking valve

序号 No.	零件名称 Part name	材料 Material			
		普通型 Ordinary type		抗硫型 Antisulphur type	
		GB	ASTM	GB	ASTM
1	排污堵头 Blowdown stops	25+Zn	A105+Zn	1Cr18Ni9	A276-304
2	阀体 Body	WCB	A216-WCB	WCB	A216-WCB
3	垫片面性 Gasket	柔性石墨+1Cr18Ni9 Graphite+1Cr18Ni9	柔性石墨+304 Graphite+304	柔性石墨+1Cr18Ni9 Graphite+1Cr18Ni9	柔性石墨+304 Graphite+304
4	阀座 Seat	16Mn+PTFE	A105+PTFE	1Cr18Ni9+PTFE	A276-304+PTFE
5	闸板 Gate disc	16Mn+NPT	A105Mn+NPT	1Cr18Ni9	A276-304
6	主撑板 Main supporting plate	WCB	A216-WCB	WCB	A216-WCB
7	副撑板 Side plate	WCB	A216-WCB	WCB	A216-WCB
8	阀杆 Stem	2Cr13	A276-420	1Cr18Ni9	A276-304
9	阀盖 Bonnet	WCB	A216-WCB	WCB	A216-WCB
10	螺柱 Stud	35CrMoA	A193-B7	35CrMoA	A193-B7
11	螺母 Nut	45	A194-2H	45	A194-2H
12	填料垫 Packing Seat	2Cr13	A276-420	2Cr13	A276-304
13	填料 Packing	PTFE	PTFE	PTFE	PTFE
14	填料压套 Packing Gland	25	A105	25	A105
15	支架 Yoke	WCB	A216-WCB	WCB	A216-WCB
16	轴承 Bearing	Bearing steel	Bearing steel	Bearing steel	Bearing steel
17	阀杆螺母 stem nut	ZQAL9-4	C95500	ZQAL9-4	C95500
18	压盖 Gland	25	A105	25	A105
19	手轮 Hand Wheel	WCB	A216-WCB	WCB	A216-WCB
20	指示罩 Indicating cover	25	A105	25	A105

• 平行式双闸板闸阀

(K)ZF44XY(K)ZF 9/544 XY-(1.6-6.4MPa)

主要外形尺寸和连接尺寸 Main Dimensions And Connection Dimensions

公称通径DN (mm)	L	D	D1	D2	b	f	z-b	H	D0
1.6MPa									
25	165	115	85	65	14	2	4-14	360	180
32	165	135	100	78	16	2	4-18	375	180
40	178	145	110	85	16	3	4-18	410	250
50	178	160	125	100	16	3	4-18	450	250
65	190	180	145	120	18	3	4-18	550	300
80	203	195	160	135	20	3	8-18	610	300
100	229	215	180	155	20	3	8-18	700	300
125	254	245	210	185	22	3	8-18	798	350
150	267	280	240	210	24	3	8-23	895	350
200	292	335	295	265	26	3	12-23	1130	350
250	330	405	355	320	30	3	12-25	1290	400
300	356	460	410	375	30	3	12-25	1480	450
350	381	520	470	435	34	4	16-25	1660	450
400	406	580	525	485	36	4	16-30	1850	500
450	432	640	585	545	40	4	20-30	2080	500
500	457	705	650	608	44	4	20-34	2300	600
600	508	840	770	718	48	5	20-41	2680	800
2.5MPa									
25	15	115	85	65	16	2	4-14	360	180
32	165	135	100	78	18	2	4-18	375	180
40	178	145	110	85	18	3	4-18	410	250
50	178	160	125	100	20	3	4-18	450	250
65	90	180	145	120	22	3	8-18	550	300
80	203	195	160	135	22	3	8-18	610	300
100	229	230	190	160	24	3	8-23	700	300
125	254	270	220	188	28	3	8-25	798	350
150	267	300	250	218	30	3	8-25	895	350
200	292	360	310	278	34	3	12-25	1130	350
250	330	425	370	332	36	3	12-30	1290	400
300	356	485	430	390	40	4	16-30	1480	450
350	381	550	490	448	44	4	16-34	1660	450
400	406	610	550	505	48	4	16-34	1850	500
450	432	660	600	555	50	4	20-34	2080	500
500	457	730	660	610	52	4	20-41	2300	600
600	508	840	770	718	56	5	20-41	2680	800

Double-disc parallel gate valve

• 平行式双闸板闸阀

(K)ZF44XY(K)ZF 9/544 XY-(1.6-6.4MPa)

主要外形尺寸和连接尺寸 Main Dimensions And Connection Dimensions

公称通径 DN(mm)	L	D	D1	D2	D6	b	f	f1	z-b	H	D0
4.0MPa											
25	165	115	85	65	58	16	2	4	4-14	370	180
32	165	135	100	78	66	18	2	4	4-18	385	180
40	178	145	110	85	76	18	3	4	4-18	420	250
50	216	160	125	100	88	20	3	4	4-18	458	250
65	241	180	145	120	110	22	3	4	8-18	555	300
80	283	195	160	135	121	22	3	4.5	8-18	615	300
100	305	230	190	160	150	24	3	4.5	8-23	710	300
125	381	270	220	188	176	28	3	4.5	8-25	790	300
150	403	300	250	218	204	30	3	4.5	8-25	900	350
200	419	375	320	282	260	38	3	4.5	12-30	1135	350
250	457	445	385	345	313	42	3	4.5	12-34	1401	400
300	502	510	450	408	364	46	3	4	16-34	1580	450
6.4MPa											
50	216	175	135	105	88	26	3	4	4-23	458	300
65	241	200	160	130	110	28	3	4	8-23	555	300
80	283	210	170	140	121	30	3	4.5	8-23	615	350
100	305	250	200	168	150	32	3	4.5	8-25	710	350
125	381	295	240	202	176	36	3	4.5	8-30	796	400
150	403	340	280	240	204	38	3	4.5	8-34	900	400
200	419	405	345	300	260	44	3	4.5	12-34	1135	500
250	457	470	400	352	313	48	3	4.5	12-41	1401	500
300	502	530	460	412	364	54	4	4.5	16-41	1580	600